



**2SB1472/2SD2224**  
PNP/NPN Epitaxial Planar Silicon Transistors  
**Driver Applications**

**Applications**

- Motor drivers, printer hammer drivers, relay drivers, voltage regulator control

**Features**

- Suitable for sets whose height is restricted
- High DC current gain
- Large current capacity and wide ASO

( ) : 2SB1472

**Absolute Maximum Ratings at Ta = 25°C**

			unit
Collector to Base Voltage	V <sub>CB0</sub>	(-)	70 V
Collector to Emitter Voltage	V <sub>CEO</sub>	(-)	60 V
Emitter to Base Voltage	V <sub>EBO</sub>	(-)	6 V
Collector Current	I <sub>C</sub>	(-)	7 A
Peak Collector Current	i <sub>cp</sub>	(-)	10 A
Collector Dissipation	P <sub>C</sub>		1.65 W
		T <sub>c</sub> = 25°C	35 W
Junction Temperature	T <sub>j</sub>		150 °C
Storage Temperature	T <sub>stg</sub>		- 55 to + 150 °C

**Electrical Characteristics at Ta = 25°C**

			min	typ	max	unit
Collector Cutoff Current	I <sub>CB0</sub>	V <sub>CB</sub> = (-)40V, I <sub>E</sub> = 0			(-)	0.1 mA
Emitter Cutoff Current	I <sub>EBO</sub>	V <sub>EB</sub> = (-)5V, I <sub>C</sub> = 0			(-)	3.0 mA
DC Current Gain	h <sub>FE</sub>	V <sub>CE</sub> = (-)2V, I <sub>C</sub> = (-)3.5A	2000	5000		
Gain-Bandwidth Product	f <sub>T</sub>	V <sub>CE</sub> = (-)5V, I <sub>C</sub> = (-)3.5A		20		MHz
C-E Saturation Voltage	V <sub>CE(sat)</sub>	I <sub>C</sub> = (-)3.5A, I <sub>B</sub> = (-)7mA		0.9	(-)	1.5 V
				(-)	1.0	V
B-E Saturation Voltage	V <sub>BE(sat)</sub>	I <sub>C</sub> = (-)3.5A, I <sub>B</sub> = (-)7mA			(-)	2.0 V
C-B Breakdown Voltage	V <sub>(BR)CBO</sub>	I <sub>C</sub> = (-)5mA, I <sub>E</sub> = 0	(-)	70		V
C-E Breakdown Voltage	V <sub>(BR)CEO</sub>	I <sub>C</sub> = (-)50mA, R <sub>BE</sub> = ∞	(-)	60		V

Continued on the next page.

**Electrical Connection**

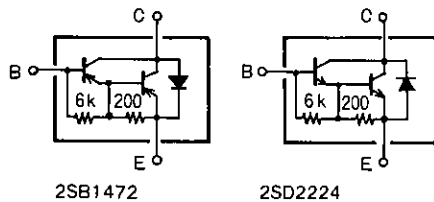

Unit (resistance: Ω)

**Package Dimensions 2049B**  
(unit: mm)

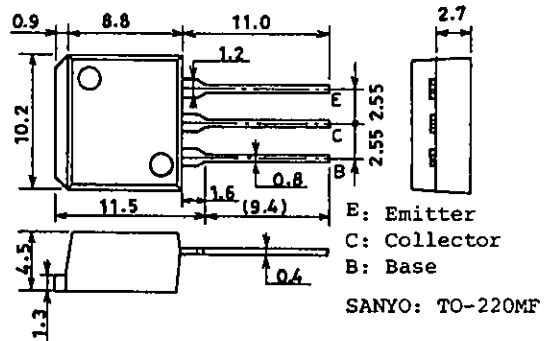

Continued from the preceding page.

			min	typ	max	unit
Turn-ON time	$t_{on}$	See specified Test Circuit.		(0.5)0.6		$\mu s$
Storage Time	$t_{stg}$	Same as above.		(1.5)3.0		$\mu s$
Fall Time	$t_f$	Same as above.		(1.4)1.7		$\mu s$

**Switching Time Test Circuit**  
(For PNP, the polarity is reversed.)

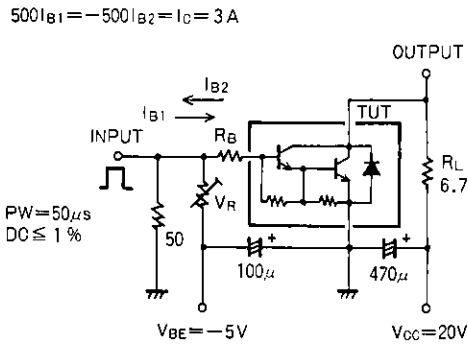

Unit (resistance:  $\Omega$ , capacitance: F)

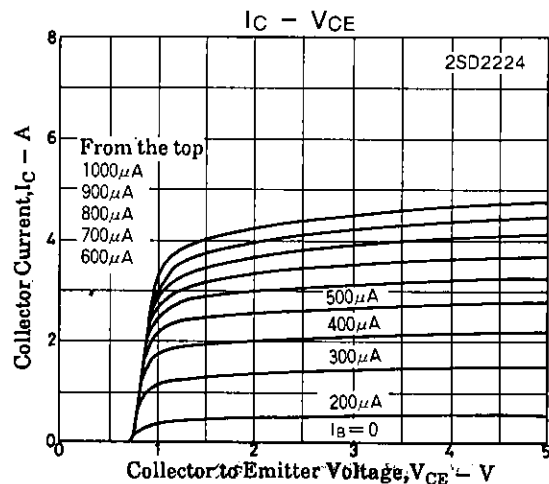
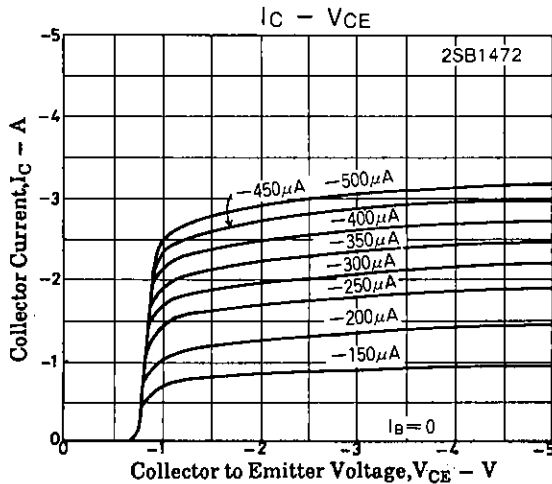
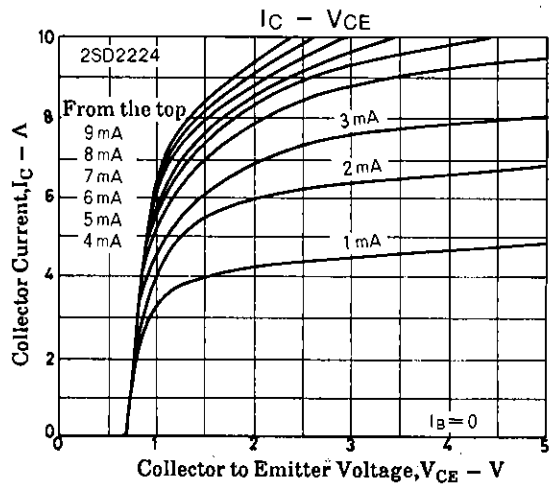
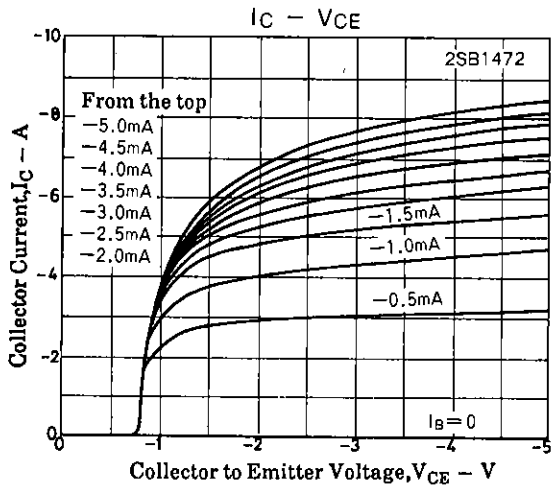

2SB1472/2SD2224

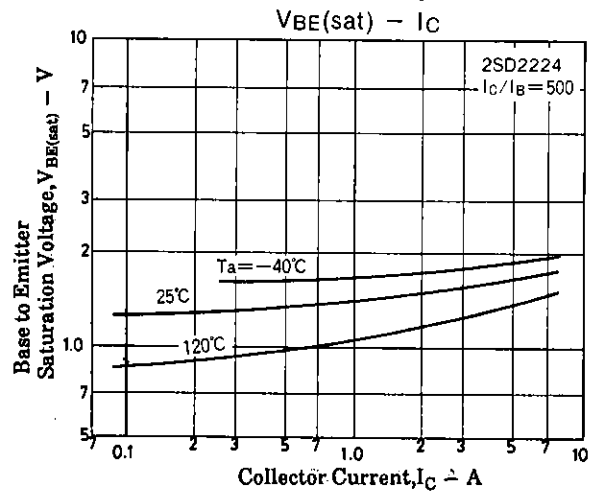
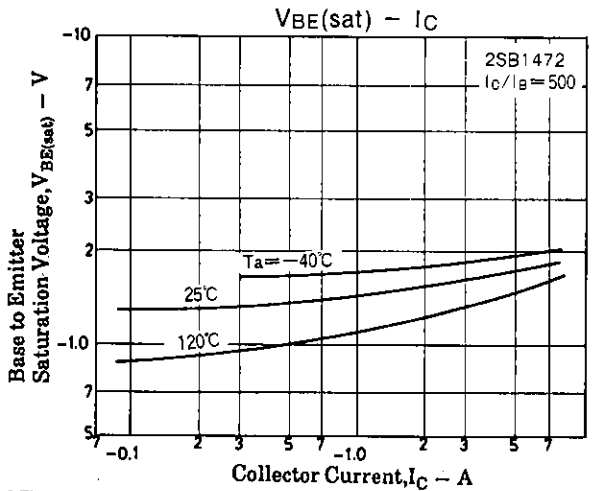
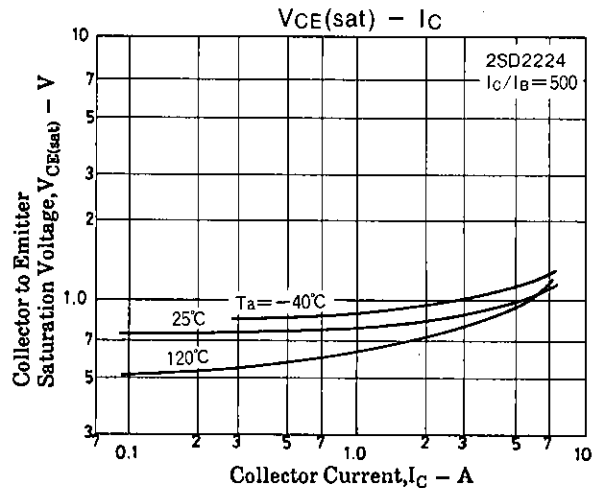
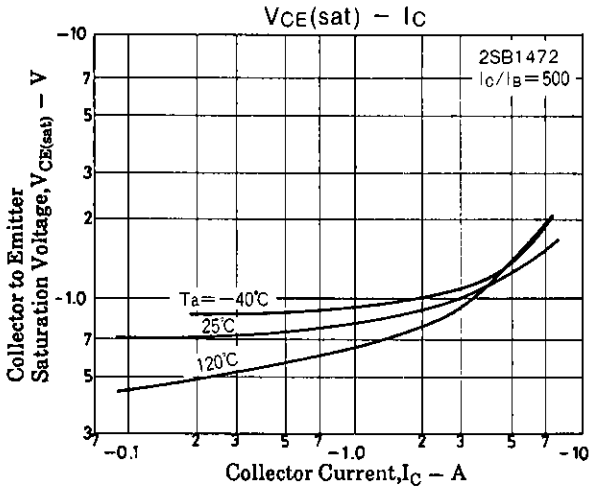
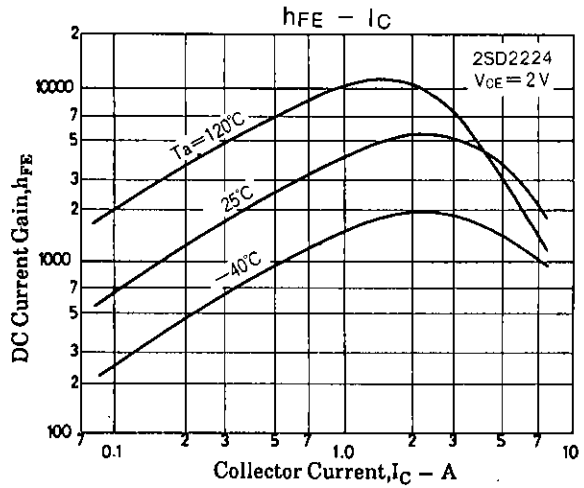
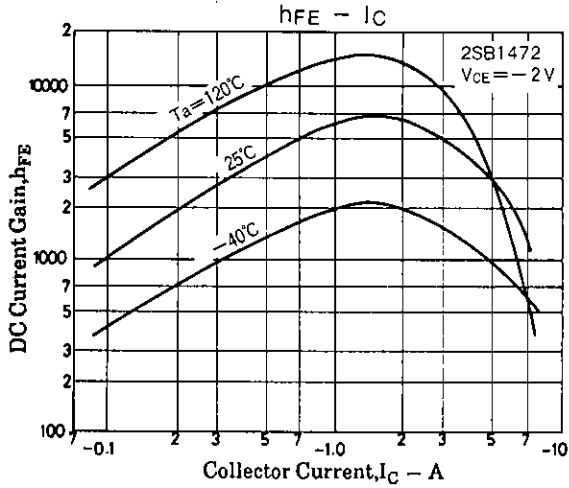
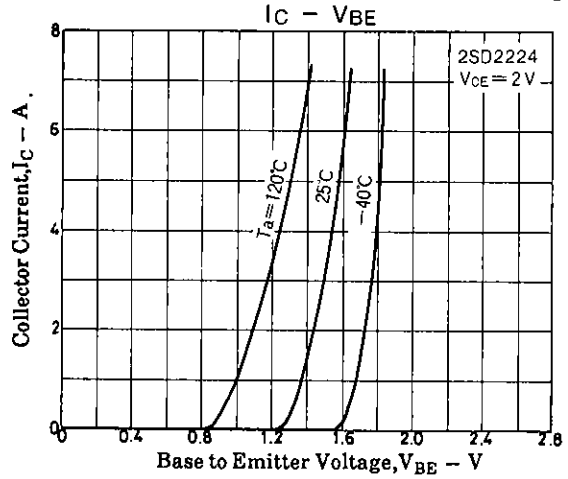
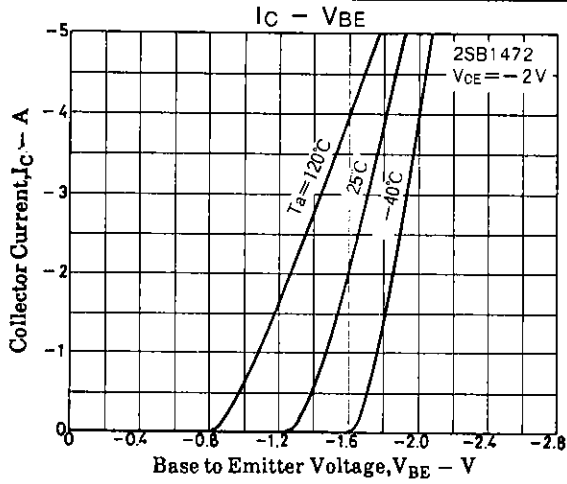

2SB1472/2SD2224

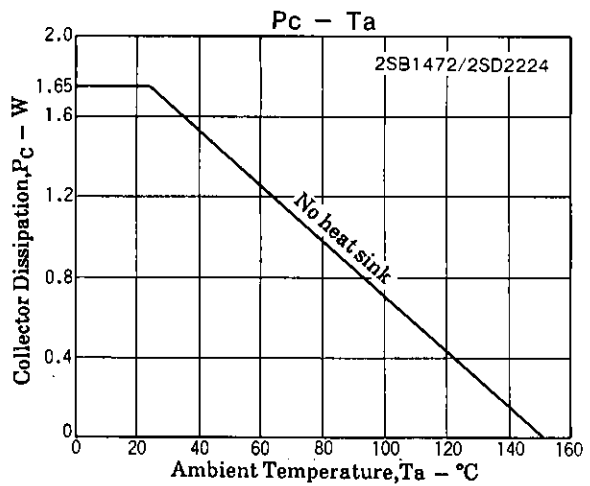
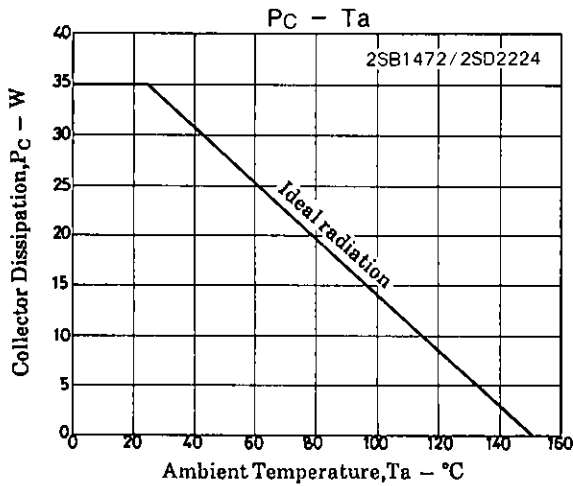
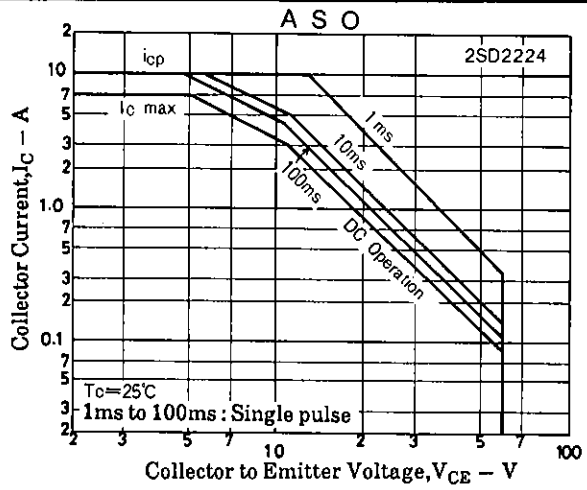
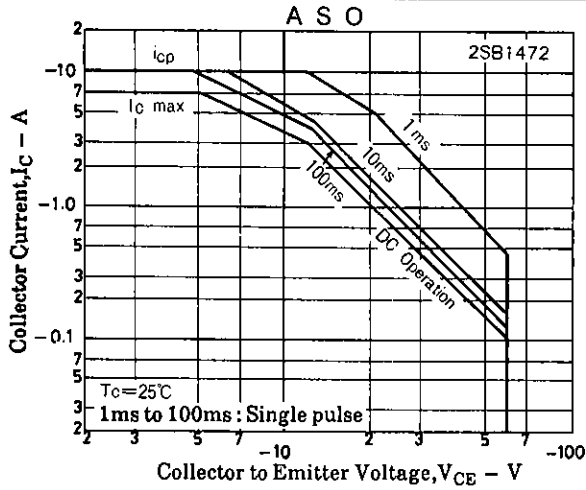

- No products described or contained herein are intended for use in surgical implants, life-support systems, aerospace equipment, nuclear power control systems, vehicles, disaster/crime-prevention equipment and the like, the failure of which may directly or indirectly cause injury, death or property loss.
- Anyone purchasing any products described or contained herein for an above-mentioned use shall:
  - ① Accept full responsibility and indemnify and defend SANYO ELECTRIC CO., LTD., its affiliates, subsidiaries and distributors and all their officers and employees, jointly and severally, against any and all claims and litigation and all damages, cost and expenses associated with such use:
  - ② Not impose any responsibility for any fault or negligence which may be cited in any such claim or litigation on SANYO ELECTRIC CO., LTD., its affiliates, subsidiaries and distributors or any of their officers and employees jointly or severally.
- Information (including circuit diagrams and circuit parameters) herein is for example only; it is not guaranteed for volume production. SANYO believes information herein is accurate and reliable, but no guarantees are made or implied regarding its use or any infringements of intellectual property rights or other rights of third parties.